

Type:

Ordering Code:

Approvals:

Job:

EFO - LED -  -  - 120  
Length CRI / CCT

Date:

Ordering Code:  Length **13, 21, 40**  CRI/CCT **735 = 70/3500K, 830 = 80/3000K, 835 = 80/3500K, 935 = 90/3500K**

**Specifications**

- Housing:** Aluminum extrusion with molded end pieces
- Lens:** Clear polymethylmethacrylate (PMMA) lens cover
- Finish:** Matte White
- Fasteners:** Steel, bright zinc plate
- Wiring:** 6' power cord supplied with each unit
- Linkable:** No
- LED/Ballast Field Replaceable:** No
- Input Voltages:** 100 - 240 Volts; 50-60Hz
- Driver:** Constant current electronic driver on board 350 mA
- Operating Temp. Range:** min -5°C max 35°C
- UL / IP Rating:** Dry location, Portable Luminaire
- Lamp Life:** 50,000 hours to 70% lumen maintenance

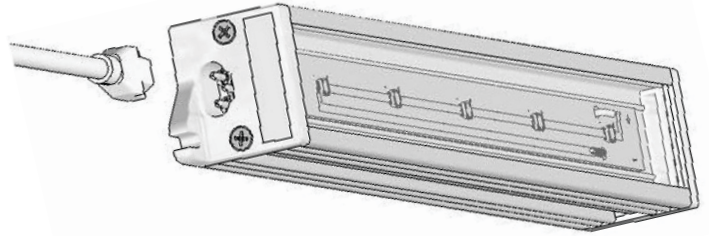

**Bullet:**



**Sprinter:**



**Express:**

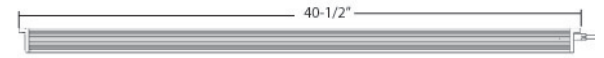

**LED Light Rail Bullet, 13"**

100/240 Volt, Aluminum Extrusion, 9 watt LED

- Weight:** 1 lb. 6 oz.
- Total Consumed Watts:** 9 watts
- Beam Angle:** 90 degrees FWHM
- Number LED's:** 5

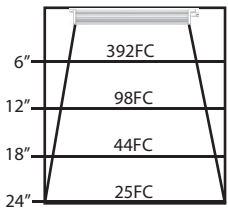
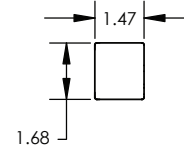
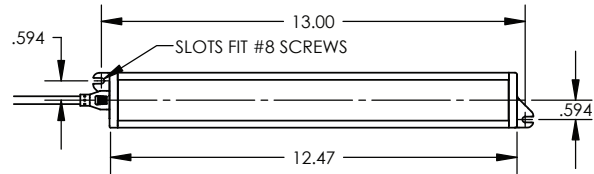

**CRI: 70**  
**CCT: 3500K**  
**Lumens: 278**

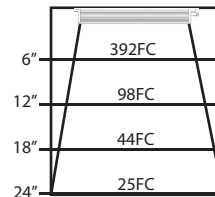
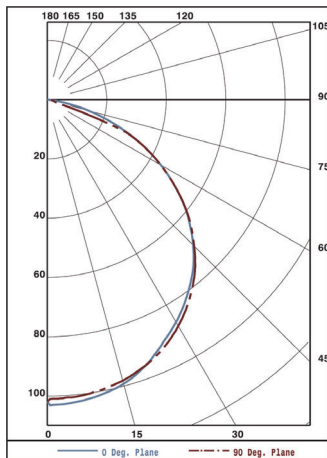

**CRI: 80**  
**CCT: 3000K/3500K**  
**Lumens: 317/311**

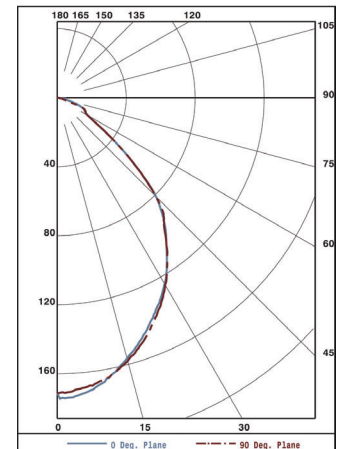

## LED Light Rail Sprinter, 21"

100/240 Volt, Aluminum Extrusion, 12 watt LED

**Weight:** 1 lb. 15 oz.

**Total Consumed Watts:** 12 watts

**Beam Angle:** 120 - 130 degrees FWHM

**Number LED's:** 9

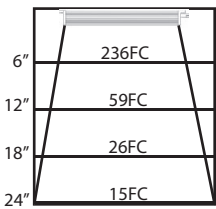
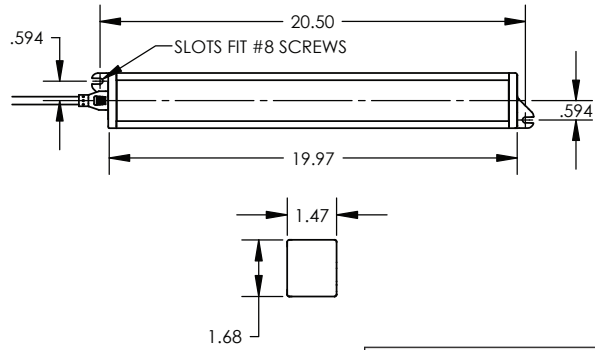

**CRI:** 80  
**CCT:** 3000K/3500K  
**Lumens:** 570/530

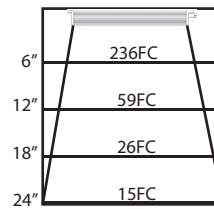
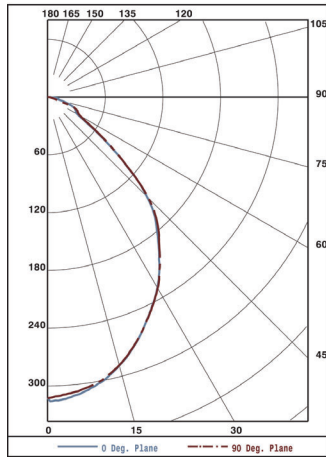

**CRI:** 90  
**CCT:** 3500K  
**Lumens:** 184

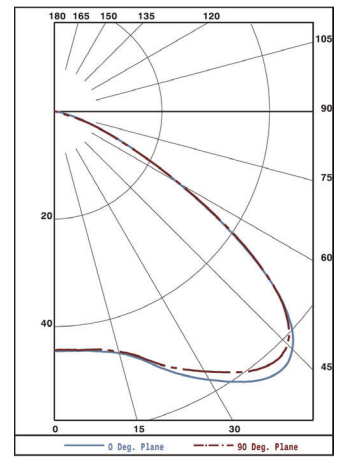

## LED Light Rail Express, 40"

100/240 Volt, Aluminum Extrusion, 24 watt LED

**Weight:** 3 lb. 14 oz.

**Total Consumed Watts:** 24 watts

**Beam Angle:** 120 - 130 degrees FWHM

**Number LED's:** 18

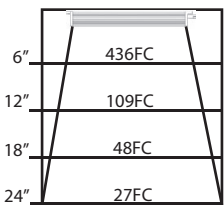
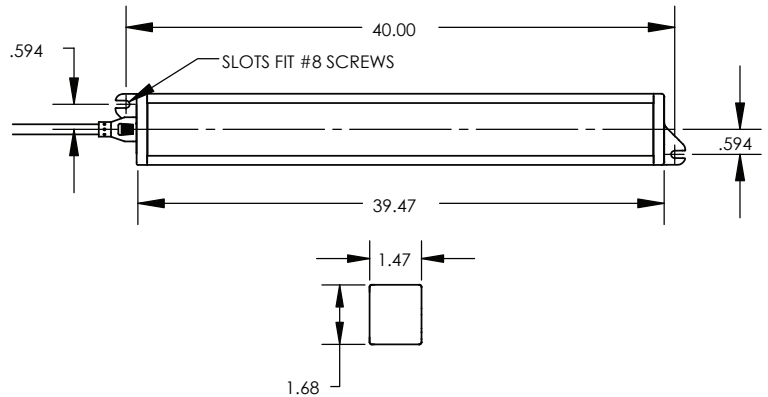

**CRI:** 80  
**CCT:** 3000K/3500K  
**Lumens:** 1130/1030

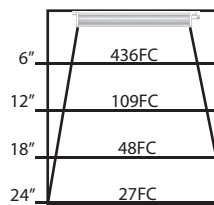
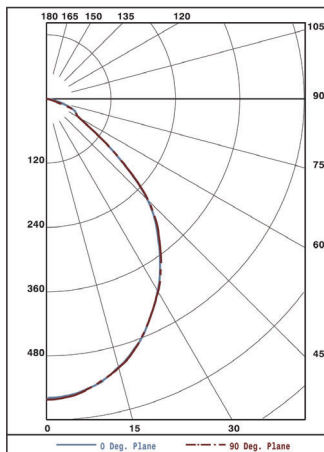

**CRI:** 90  
**CCT:** 3500K  
**Lumens:** 393

